

USB Wireless Transmitter and Receiver to HDMI Display - ID# 722



Operation Manual

Introduction

The USB wireless transmitter and receiver to HDMI display can allow you to view any PC information on a compatible TV with a wired like experience. An additional feature of this product is that it includes extra USB ports allowing it to perform KVM operations next to the TV, which is an added bonus for those of us who are multi-taskers.

Applications

- Wirelessly send Audio and Video from your PC to an HDTV
- Watch Internet TV on big screen, wirelessly

System Requirements

- System Hardware Requirements: 2.4 GHz single core CPU with at least 1GB RAM for optimal performance
- Operating Systems:
 - Windows 2K SP4
 - Windows XP Home or Professional 32 bits SP2
 - Windows Vista 32 bits
 - Windows 7
- USB Port Extension:
 - An available USB 2.0 port with USB to mini USB cable
- It is suggested to upgrade your systems graphics drivers, Display Link software and the mother boards chip set driver to their latest version

Features

- Worldwide Band Groups 1,3,4 and 6
- Completely Integrated Baseband (BB)
- Supports HDMI & VGA outputs
- 16/32-bit Color for high-quality images
- HD resolution up to 1920 x 1080
- Has a broadcast range of 10 meters
- Speed up to 150MB/s
- HDMI and RGB display connectivity
- EDID selection with switch for VGA or HDMI output
- Secure and easy to use

Operating Functions and Controls Transmitter

The following sections describe the hardware components of the unit and include a step by step installation guide and other suggested settings.



Connect the wireless USB dongle to a PC or Laptop to deliver fast and reliable media through the use of Ultra Wide Band (UWB) technology.

Receiver

Front Panel

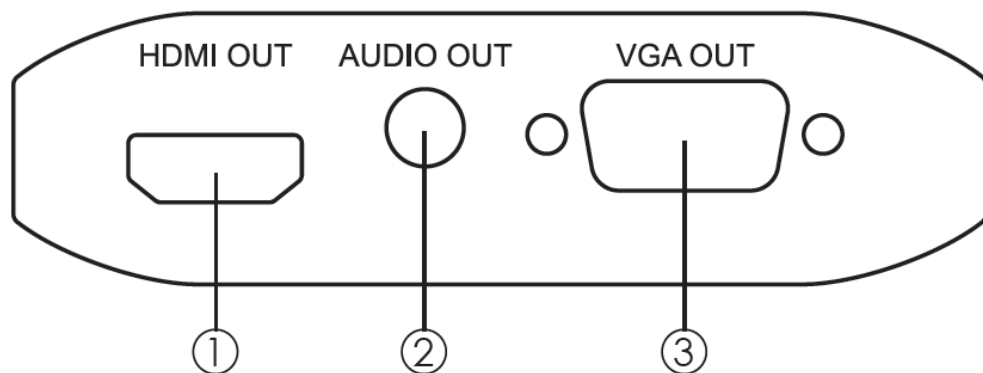

- ① **HDMI OUT:** Connect the HDMI output to the HDMI display.
- ② **AUDIO OUT:** Connect the audio output to the speaker or AVR.
- ③ **VGA OUT:** Connect the VGA output to the VGA monitor.

Note: HDMI and VGA can output at the same time.

Rear Panel

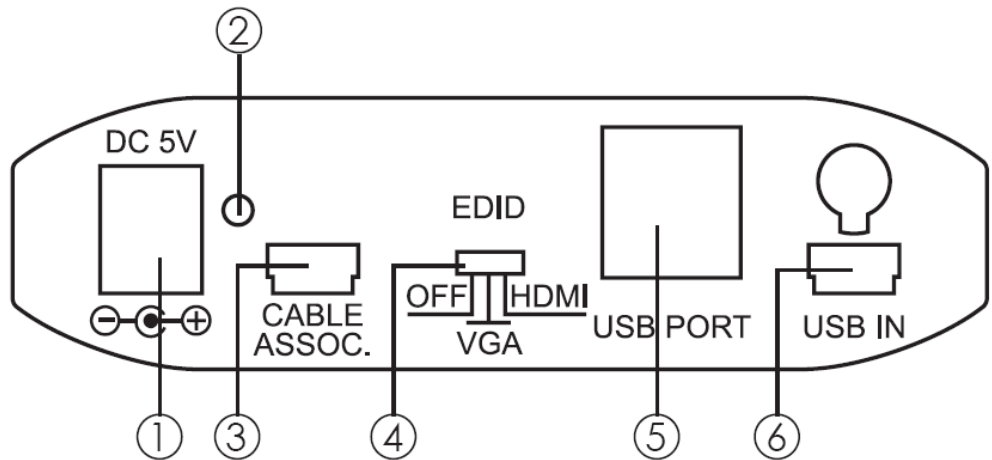

- ① **Power:** This slot is where the user plugs in the 5V DC power supply of this unit before connecting the adaptor to an AC wall outlet.
- ② **Link LED:** When the LED is on it means the system is ready and there is audio and Video can be sent.
- ③ **CABLE ASSOC.:** This slot is where the user connects a USB cable to the PC or Laptop USB port for ID association when first using the system and later on when establishing a connection with the Transmitter.
- ④ **EDID control switch:** The default setting for this switch is HDMI, leave the switch here as long as the connected display is compatible. When the EDID control is switched from HDMI to VGA the unit will detect the sources EDID and record it. Turn off in order to use the built in EDID.
- ⑤ **USB Port:** These ports allow the receiver to act like a USB hub, allowing you to connect an External Hard Drive, Keyboard or Mouse.

Note:

- These two USB ports cannot be connected to a USB extension hub, doing so will trigger the system to detect the external Hub and will cause a system failure.
 - Before removing the USB device, the user must follow the USB devices hardware removal procedure. Failure to do so will cause the system to crash.
- ⑥ **Mini USB IN:** This port supports This port support mirror or video extension (via USB cable) to your HDMI display, including both video and audio output signals.

Software Installation

The following sections list the procedures to follow when installing the USB to HDMI and USB device drivers. Insert the provided CD into your CD-ROM drive, then begin the Wireless USB Install Disc and follow the below steps to install the driver.



Install Microsoft Net Framework 2.0

Step 1: Click Install Microsoft Net Framework 2.0 to start the installation process.

Step 2: Click "Next" to start the setup.

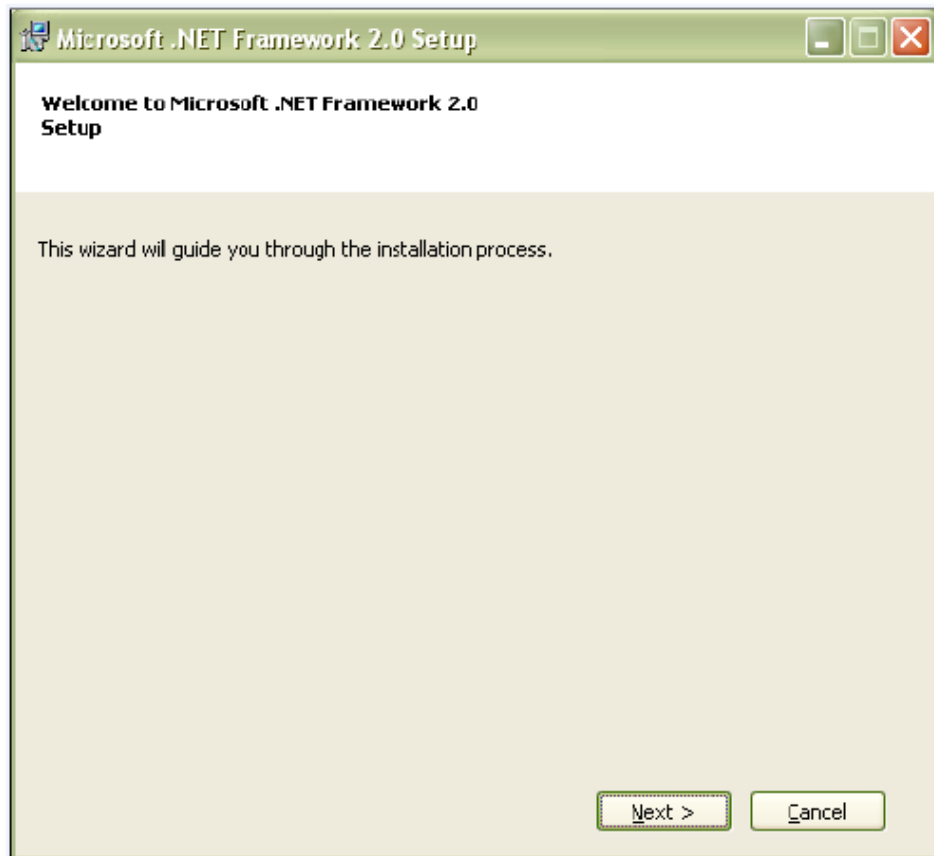

Step 3: Click "I accept the terms of the License Agreement" and go to the Next page.

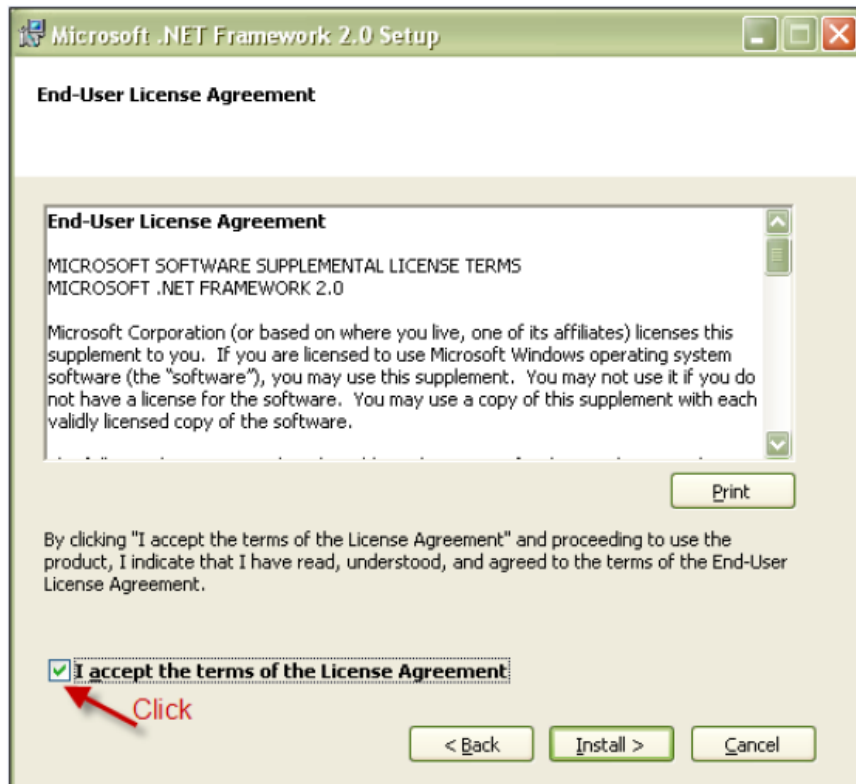

Step 4: Click "Finish" to complete the installation.

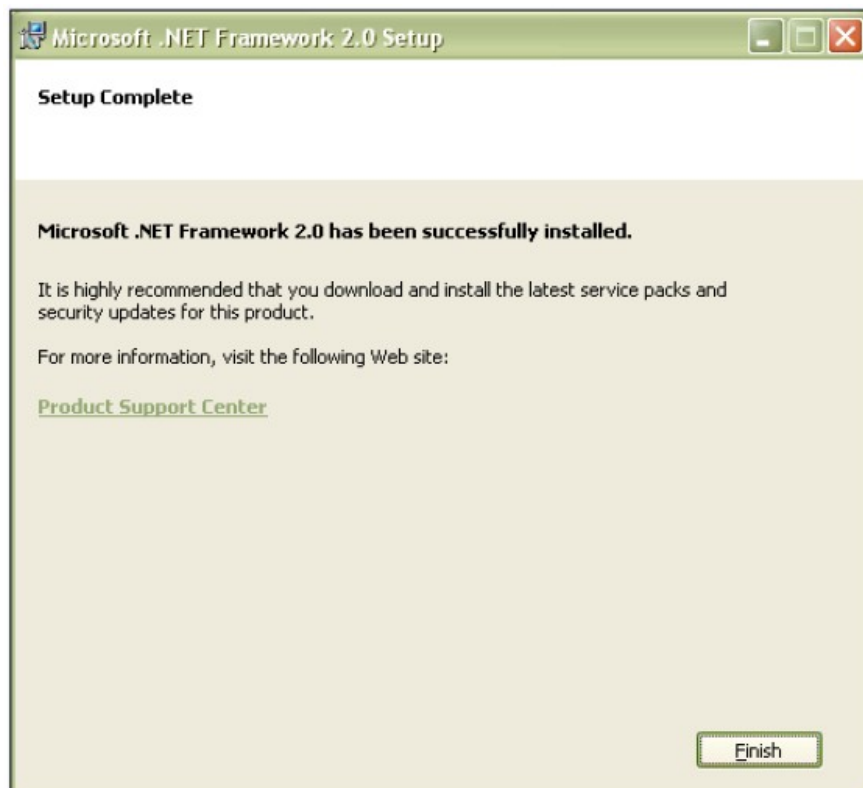

Install Wireless USB Manager

Step 1: Click "Next" to Install Wireless USB Setup



Step 2: Click "I accept the terms of the License Agreement" and go to the Next page.

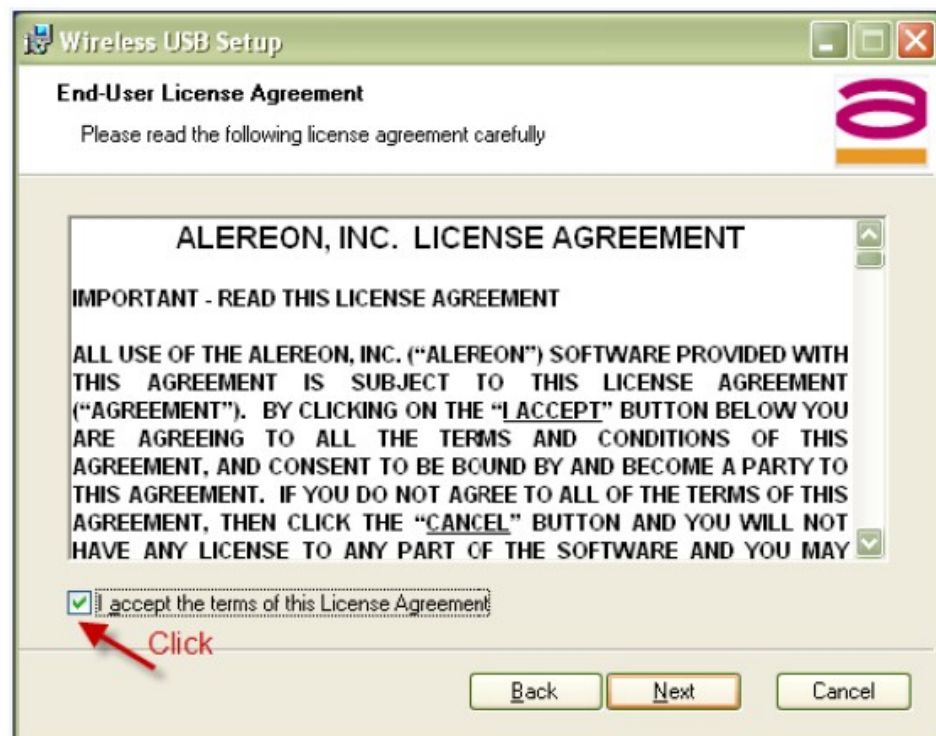

Step 3: Select the installation folder for the Wireless USB.

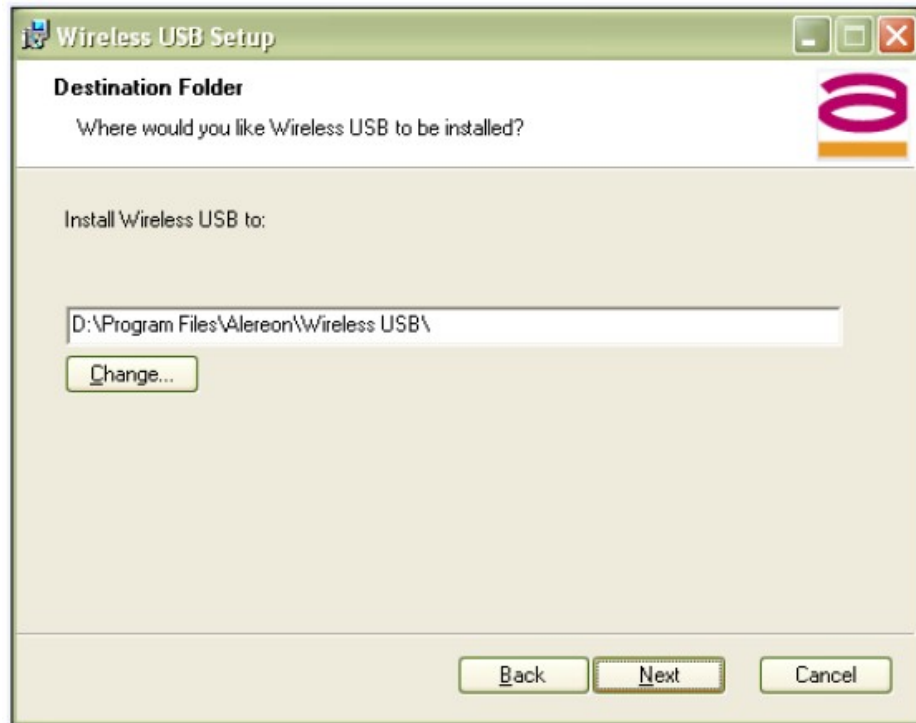

Step 4: Click "Install" to begin installing

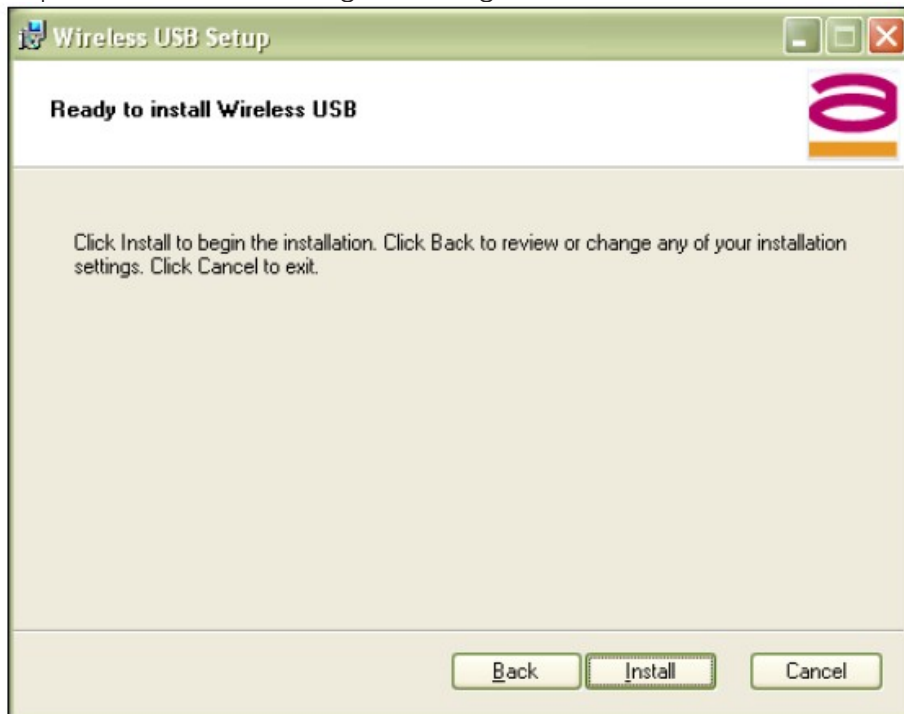

Step 5: For the software installation, click "Continue Anyway" to continue installing the software.



Step 6: Click Finish to complete the Wireless USB installation



Install DisplayLink Software

Select the preferred language and click automatically check for updates, and then click "I Accept" to install the DisplayLink Manager

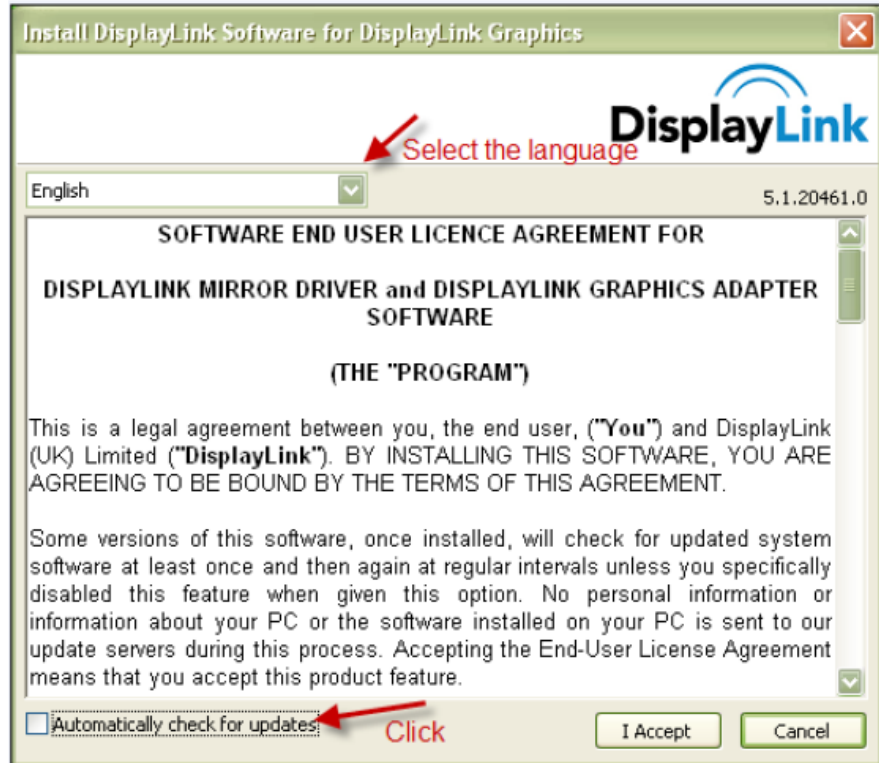

Hardware installation

After inserting the Wireless USB dongle into the computers USB Port, the user needs to follow the system guidelines in order to install the Wireless USB dongle.

Step 1: It is recommended to select "Install the software automatically" to install the Alereon WUSB Radio Controller interface and click "Next" to start installing the driver.



Step 2: To install Alereon WUSB Radio Controller Interface, click "Continue Anyway" to continue to install the software

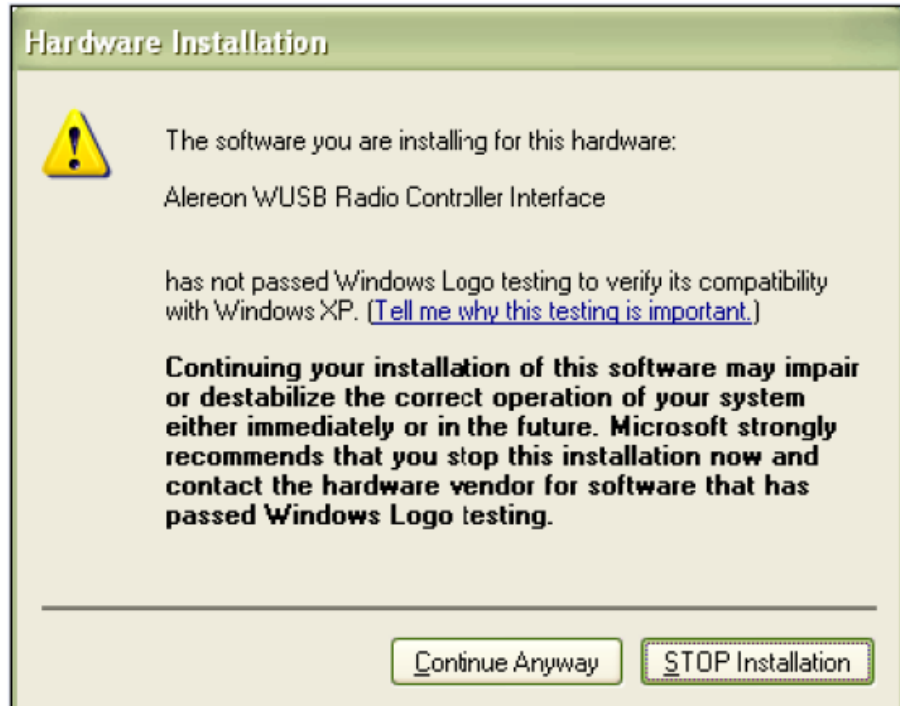

Step 3: Click "Finish" to complete the Alereon WUSB Radio Controller Interface installation

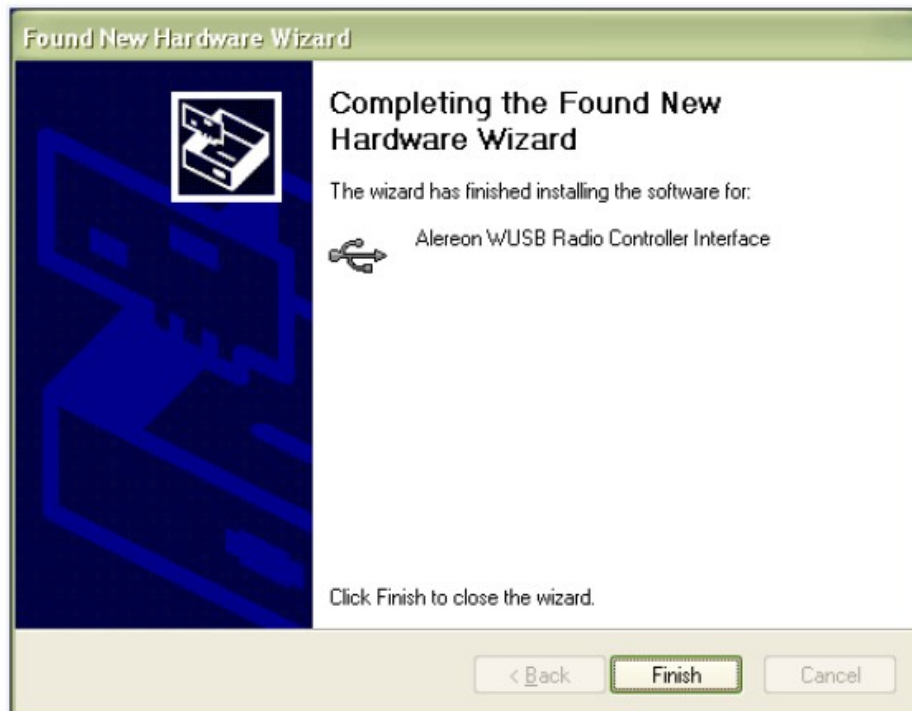

Step 4: Select "Install the software automatically" to install Alereon WUSB Host Adapter, click "Next" to start installing the driver.



Step 5: To install Alereon WUSB Host Adapter, click "Continue Anyway" to continue to install the software



Step 6: Click "Finish" to complete the Alereon WUSB Host Adapter installation

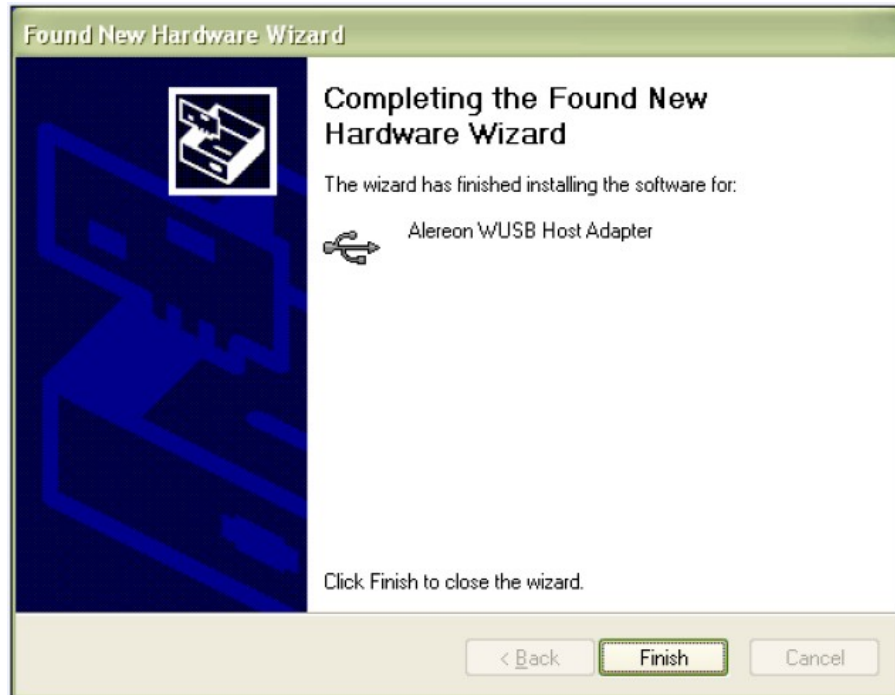

Step 7: It is recommended to select "Install the software automatically" in order to install Alereon Wireless USB Graphics Adapter w/Audio and click "Next" to start installing the driver.



Step 8: To install Alereon Wireless USB Graphics Adapter w/Audio, click "Continue Anyway" to continue to install the software



Step 9: Click "Finish" to complete the Alereon Wireless USB Graphics Adapter w/Audio to finalize the installation process.



Using Wireless USB Manager Running Wireless USB Manager

Before the system has been connected the screen will show "Not Connected"



Select Connection Rules item

To connect a device for the first time the user must form an association

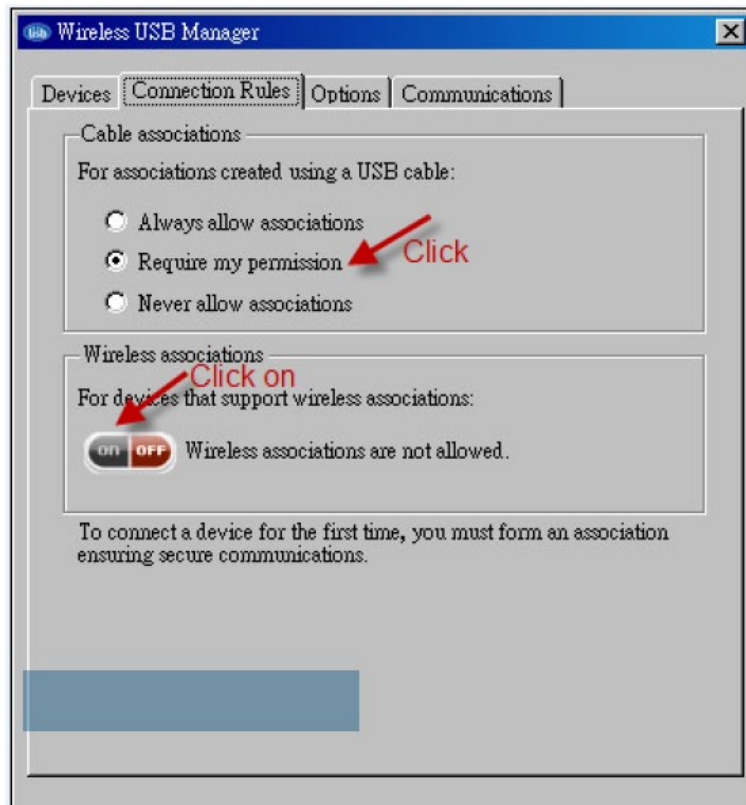

System Association

Enter pin code to associate with your computer



Enter pin code "Alereon!" and click "Complete the association with this device"



Association is successful

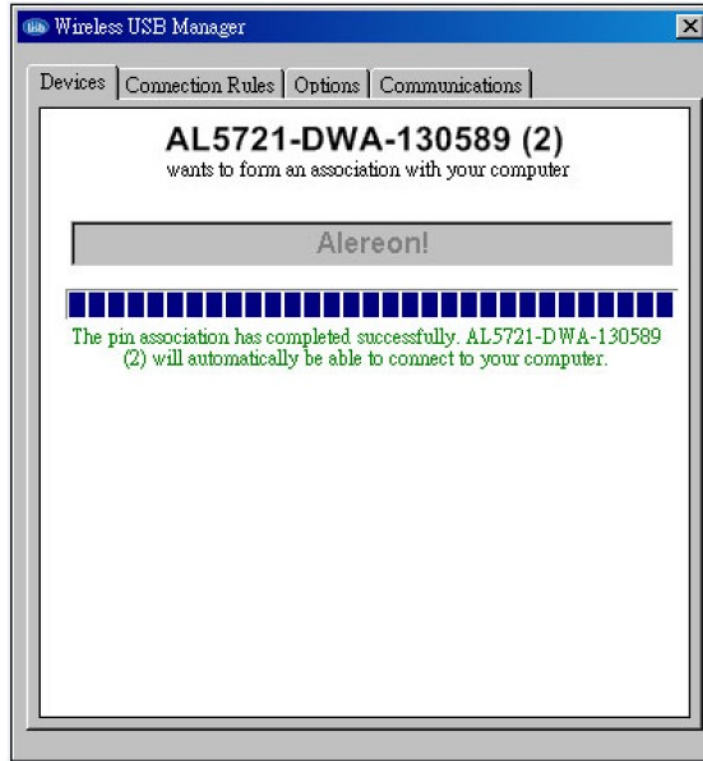

Device Connection



Using DisplayLink Manager

After the driver is installed, a utility (DisplayLink Manager) will automatically appear in the system tray. The utility allows you to quickly change the settings and resolution for DisplayLink Manager. Right click on the icon will bring out the context menu.

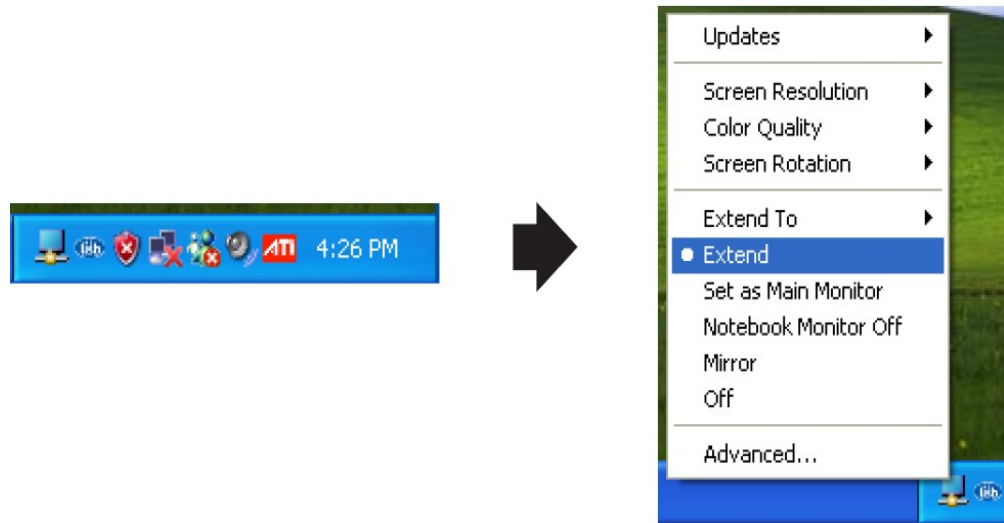

Screen Resolution: Select the screen resolution (available only in extended mode).

NOTE: When the display has a built in EDID the screen will show the displays resolution, if no EDID is present the screen has the following resolution (see below image)

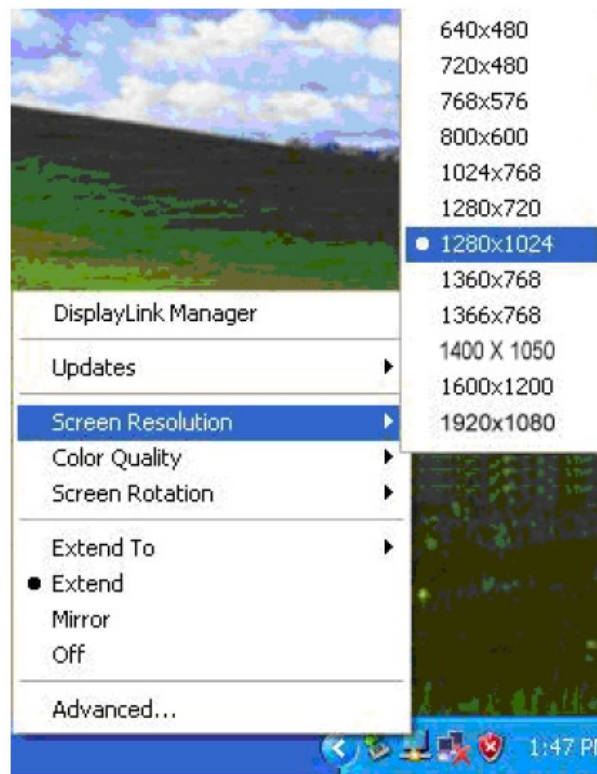

Color Quality: Select the screen color quality (available only in extended mode).

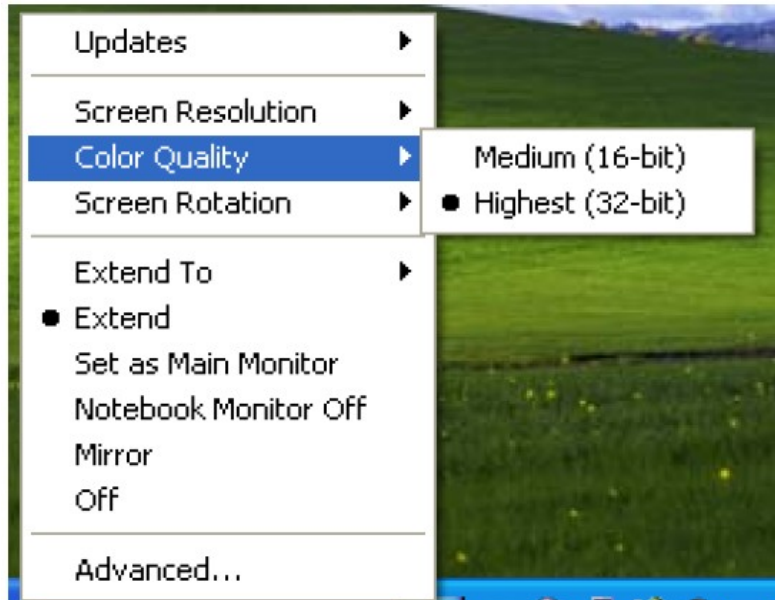

Screen Rotation: Rotate the screen on the additional monitor by 90, 180 or 270 degrees.

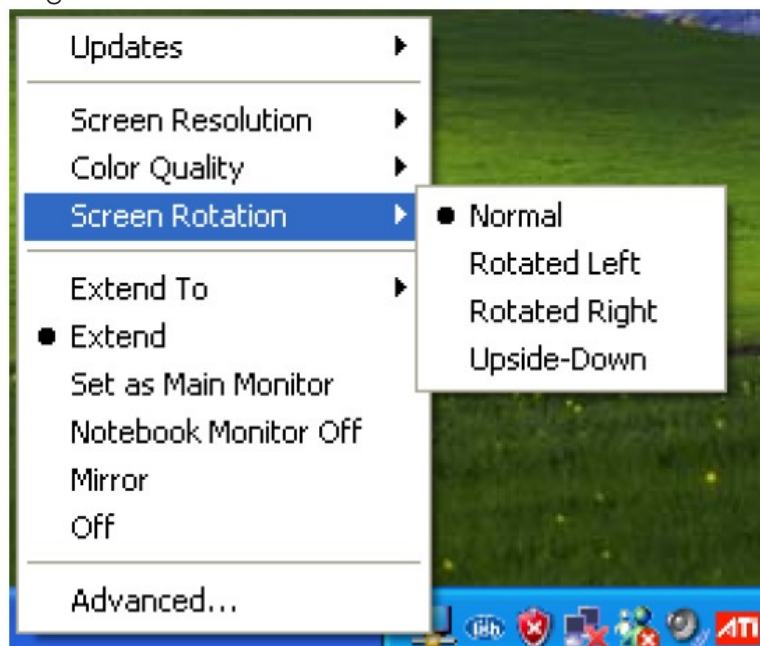

Extend to: Reposition the extended screen to the top, bottom, left or right of the primary display.

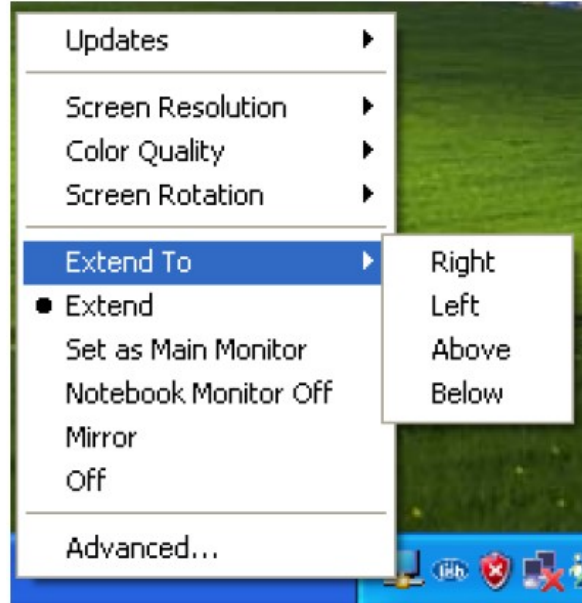

Extend: Set the DisplayLink Manager to Extended mode.

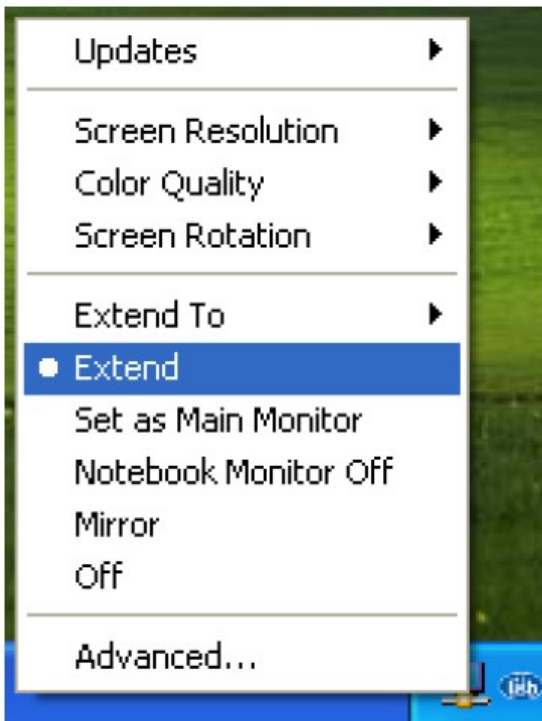

Set as Main Monitor: Set the monitor to be the main monitor.

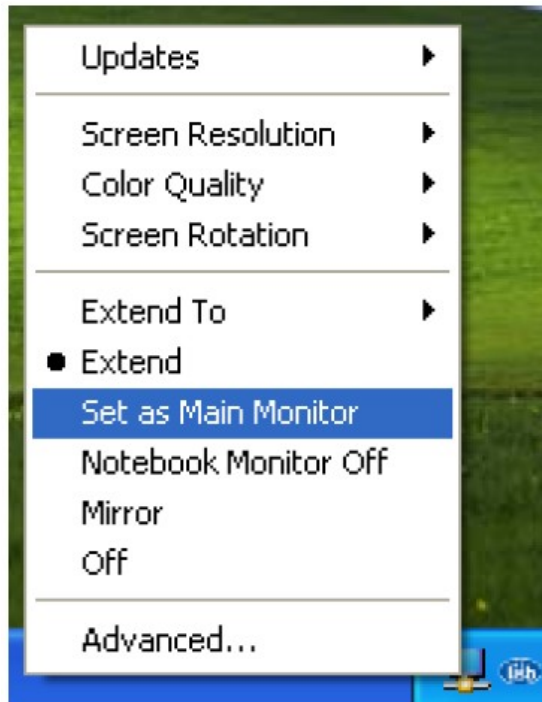

Notebook Monitor off: Set the PC/notebook's monitor off.

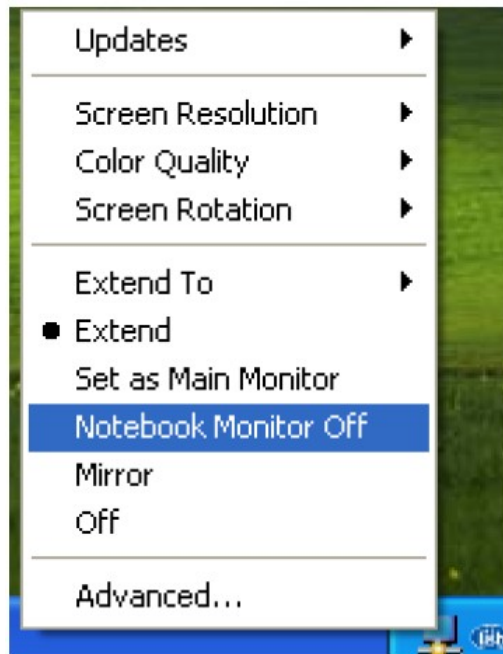

Mirror: Set the DisplayLink Manager to Mirror mode. You can see the same desktop image on the additional monitor.

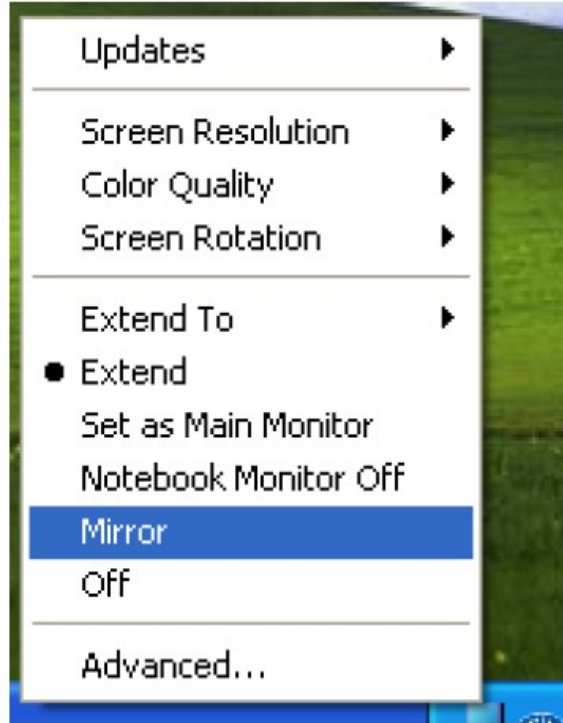

Off: Disable the DisplayLink Manager on the system.

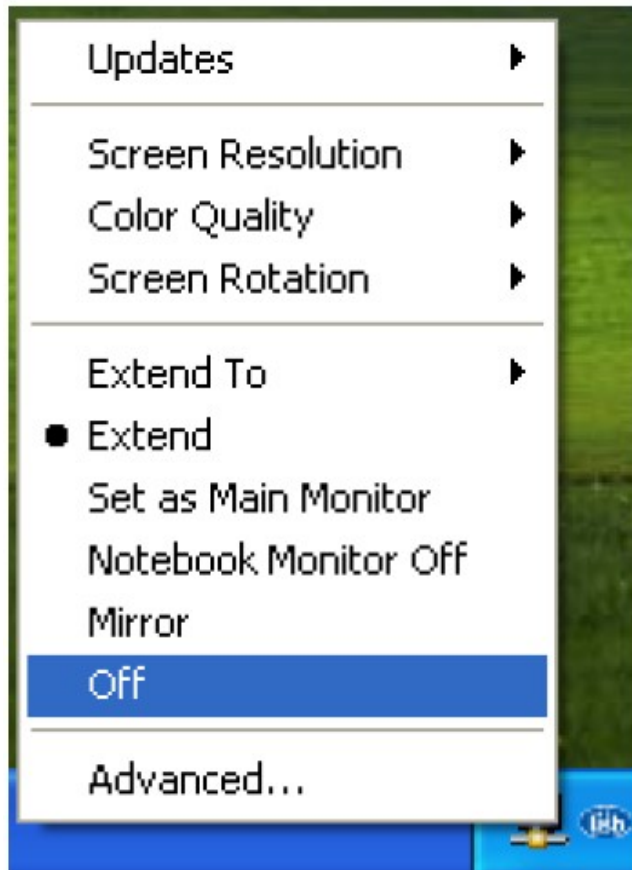

Advanced: Opening the **Display Properties** will allow you to adjust the resolution, color quality, position and refresh rate.

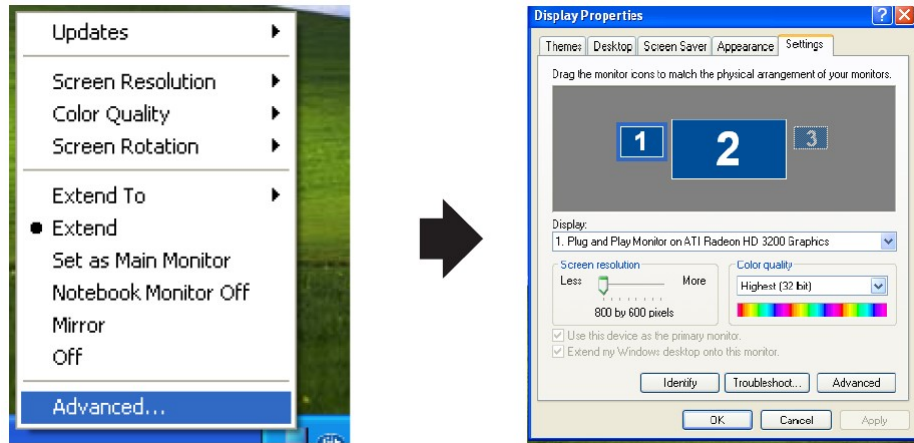

Using More DisplayLink manager

You don't have to install a new driver as long as you have completed the above installation process in advance. It will automatically define the ID of the new Display Link Manager and will list everything in the Display properties or the display manager menu.



NOTE: When connecting more DisplayLink Manager to a computer, a system with higher CPU performance is recommended.

Firmware Update

Click the **Updates** → **Check Now...**, to search for and download the latest firmware.

NOTE: Confirm that your computer is already connected to the network.

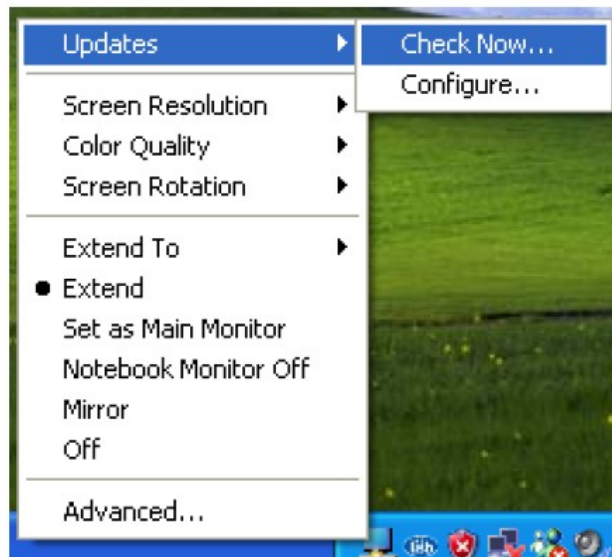

Automatic Update

Click the **Updates** → **Configure...**, the **Updates Options** window will appear as shown below. You can set the update method and frequency in the windows.

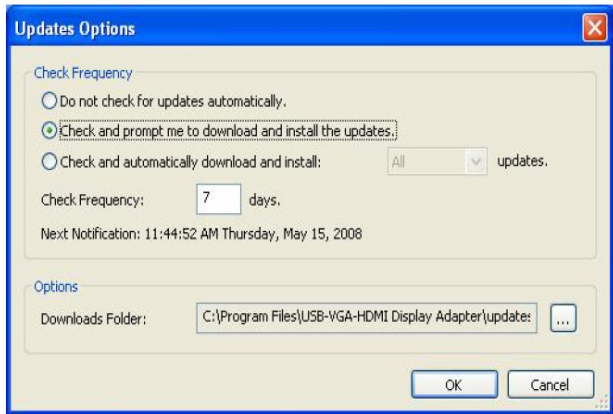
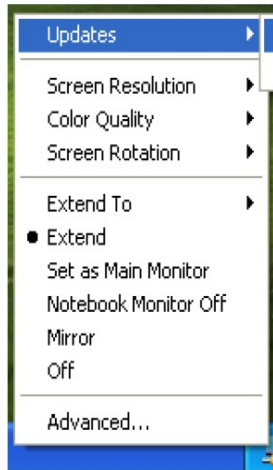

Uninstall the Device Driver

Follow the steps below to uninstall the Multi View driver.

Step 1: Open the Control Panel: **Start** → **Control Panel** → **Add or Remove Programs**.

Step 2: Select **USB-VGA-HDMI DisplayLink Adapter** and click **Remove**.

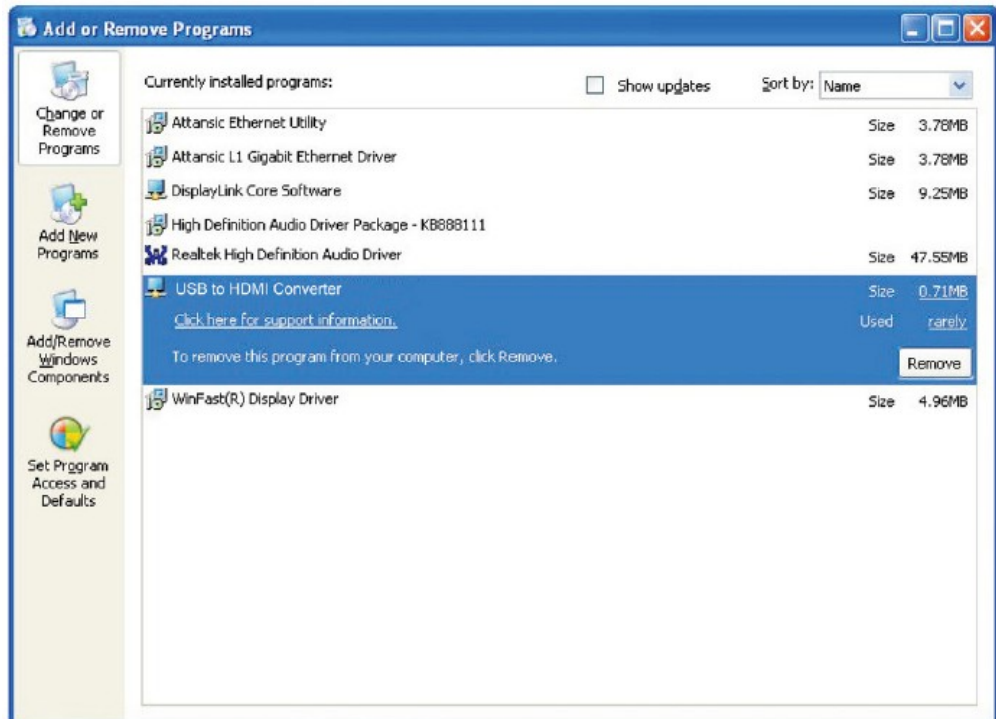

Step 3: Click Yes to confirm the removal.



Step 4: Click Yes to restart your computer.



Installation

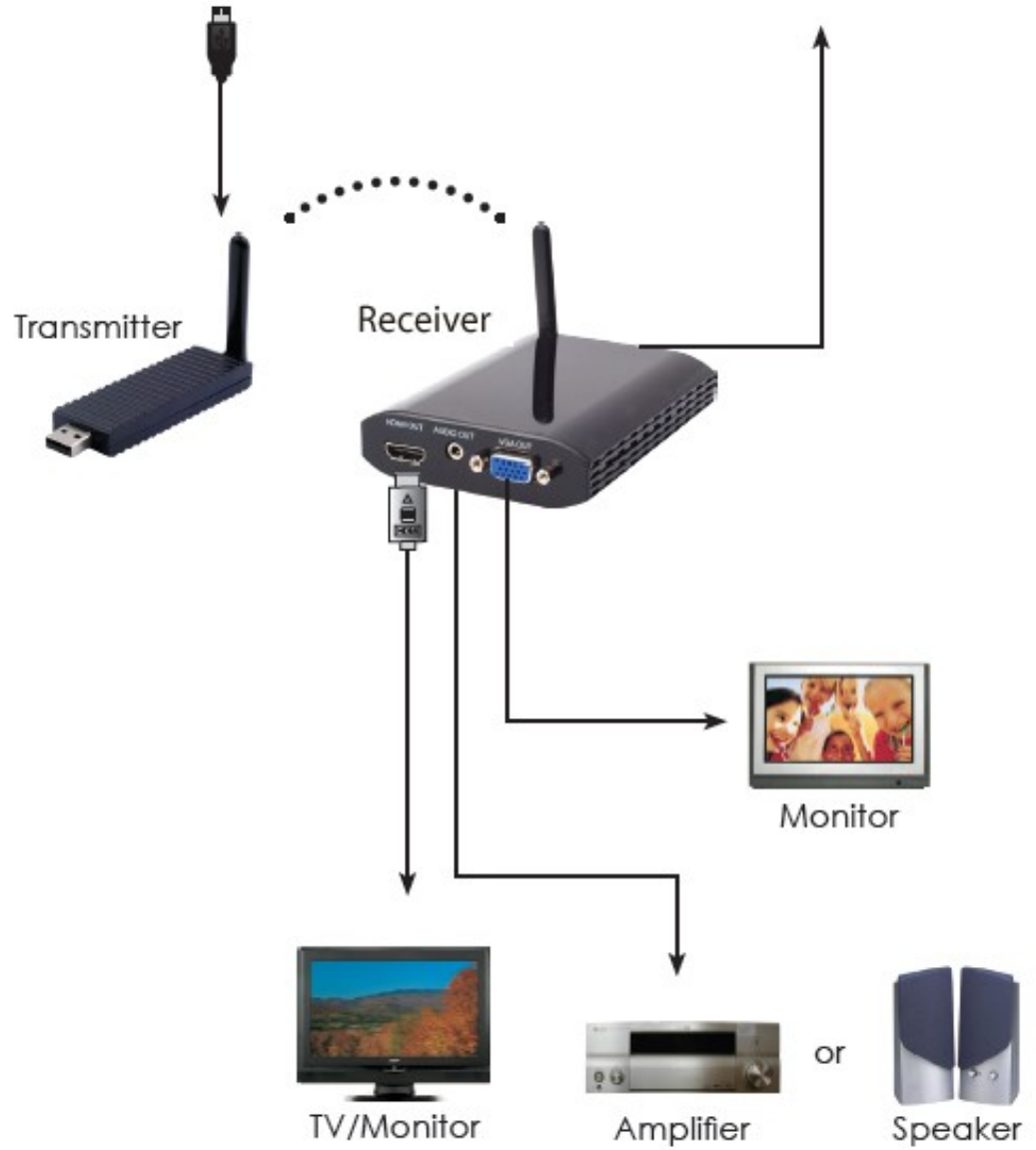

Specifications

Input Port	1 x Mini USB
Output Ports	1 x HDMI, 1 x D-Sub 15pin, 3.5Φ phone jack
Extender Ports	2 x USB Hubs (A type)
Power Supply	5V DC/2.6A (US/EU standards, CE/FCC/UL certified)ESD Protection
Human body model:	± 8kV (air-gap discharge)± 4kV (contact discharge)
Dimensions (mm)	Transmitter: 81(W) x 25(D) x 11(H) Receiver: 90(W) x 120(D) x 25(H)
Weight(g)	Transmitter: 22 Receiver: 120
Chassis Material	Transmitter: Plastic Receiver: Plastic Silkscreen
Colour	Transmitter: Black Receiver: Metal Black
Power Consumption	Receiver: 8W
Operating Temperature	0°C ~ 40°C / 32°F ~ 104°F
Storage Temperature	-20°C ~ 60°C / -4°F ~ 140°F
Relative Humidity	20~90% RH (non-condensing)