

# 3D Mini HDMI Analyzer

- ID# 873



**Operation Manual**

## Introduction

The 3D Mini HD Analyzer is a tool for checking the compatibility of 3D sources and displays. featuring touch sensitive controls with an OLED display that shows the input and output timings, the mini analyzer analyzes the input sources of the sources info frame and the output sinks EDID to ensure the compatibility of the source and display.

## Features

- Supports Timing include SD, HD up to 1080p, PC up to WUXGA and 3D
- Provides 25 timings, 6 patterns and 1 pattern for 3D timing
- Deep color video up to 12 bits, 1080p@60Hz
- Supports input signal bypass, digital video formats in Deep Color Mode at up to 36 bits (12 bits/color) and new lossless compressed (Dolby TrueHD, Dolby Digital Plus and DTS-HD master Audio) digital audio
- Supports internal pattern audio LPCM 2CH 48/96/192KHz, LPCM 5.1CH 48/96KHz, LPCM 7.1CH 48/96KHz
- Analyze input source info-frame and output sink EDID
- Touch button control function
- OLED show Input / Output timing information
- Supports ARC (Audio Return Channel) follow by HDMI v1.4 specification
- Supports Deep Color (8/10/12bits) output
- Supports HDCP repeater and complaint with HDCP
- Supports CEC bypass

## Applications

- Apparatus testing
- Equipment adjustment
- EDID checking
- HDCP verification
- Production testing
- RD design

## System Requirements

HDMI input port connected to the source/HDMI system with HDMI cable and HDMI output connected to the display/HDMI system with HDMI and or amplifier.



## Operation Controls and Functions

### Front Panel

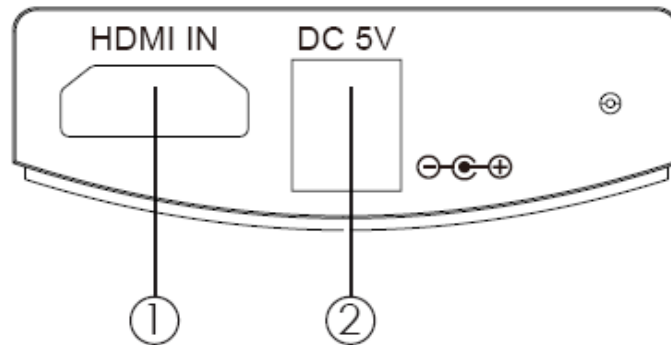

- 1. HDMI IN:** Connect the HDMI input port to the HDMI output port of your source equipment such as DVD, Computer, Cables Box or any other source for testing and pulling EDID file.
- 2. DC 5V:** Plug the DC 5V power supply into the splitter and connect the adaptor to AC wall outlet.

### Rear Panel

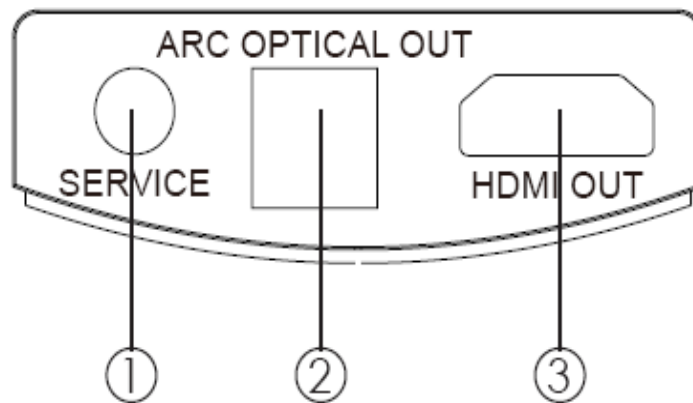

- 1. SERVICE:** Use DB9 to 3.5φ phone jack to do the software upgrade yet this feature is not open to end user. The DB9 to 3.5φ phone jack is not included in the package.
- 2. ARC OPTICAL OUT:** For the ARC, the user had a TV with a built-in tuner or DVD player and wanted to send content "upstream" from the TV back to the audio system (such as Audio Video Receiver) to play any multi-channel audio.
- 3. HDMI OUT:** This connection is for connecting the generator to a display or devices before the display when testing the full system capabilities.

## Top Panel

**Note:** Please remove the plastic film from the top before using the touch key function.

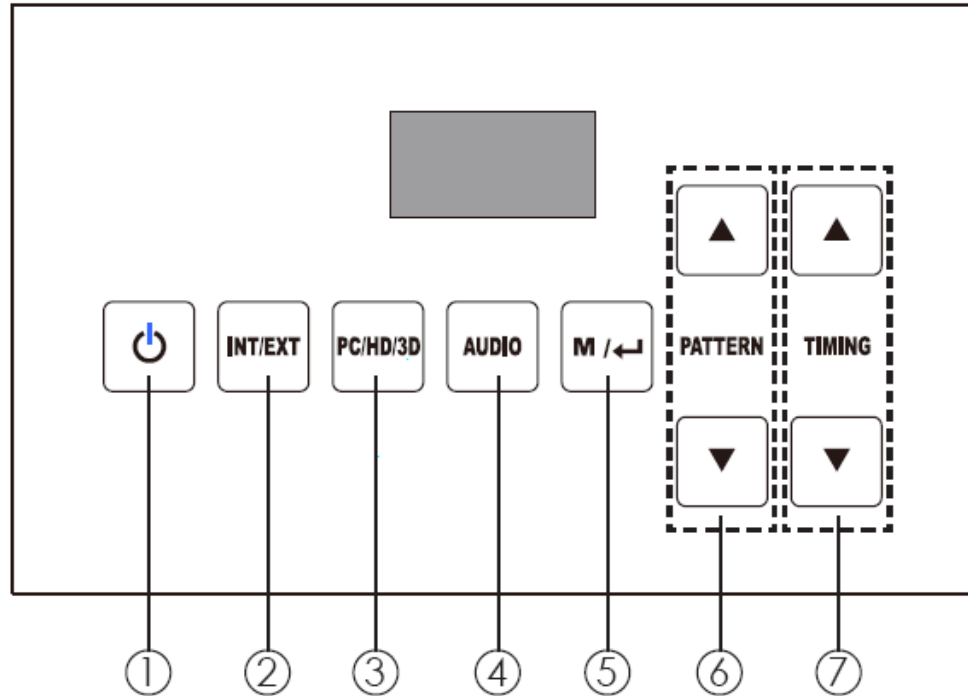

- 1. Power:** Press this button to turn on or set the device to standby mode. The blue LED will illuminate when the device is set to on and the red LED will illuminate when the device is switched to standby mode.
- 2. INT/EXT:** Press this button to select the internal patterns built-in from the device or the external device's EDID connected from the output port. The LED will not illuminate when the internal patterns is selected and when the external EDID is selected the LED will illuminate in blue. To use the external EDID function, input slot must be connected with source signal in order to perform if not, the device will only send out the internal patterns to display on the TV/monitor and the internal pattern is with last memory function.
- 3. PC/HD/3D:** Press this button to switch patterns quickly from PC/HD or 3D and the OLED will display the patterns for users selection.
- 4. AUDIO:** Press this button to select audio's sample rate from LPCM 2CH, LPCM 5.1CH and LPCM 7.1CH 48KHz or LPCM 2CH, LPCM 5.1CH and LPCM 7.1CH 96KHz or LPCM 2CH and LPCM 5.1CH 192KHz. Press it for 3 second to enter into Audio mute function.
- 5. M/← :** Press this manual to enter into OSD manual and or confirm the selection.
- 6. PATTERN ▲/▼:** Press these keys to select patterns or when in OSD manual press these keys to select for option.
- 7. TIMING ▲/▼:** Press these keys to select timings.

## OSD Menu

Press the M/↔ button from the device to bring up the OSD on the display.  
Press pattern's [▲/▼] to highlight on option  
Press [M/↔] to confirm the selection

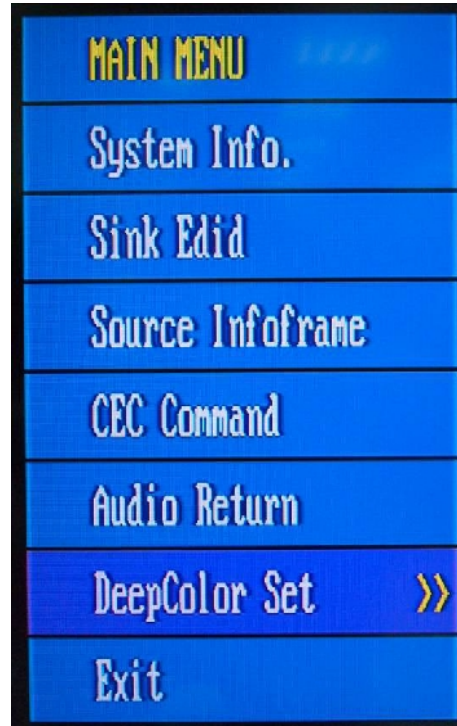

## System Info

**System Info.:** Press this button to show both the input and output information while both input and output is connected, refers to below picture for information contents. When connection output display only, press this button repeatedly to bring up the patterns for display



Press [M/←] to check the input/output device information and software version.

#### Sink EDID

Option	Description
Block Data	To check the sink Block0 and Block 1's table of EDID
Description	

#### Source Info-frame

Option	Description
AVI (AVI info-framedata)	To check the source video info-frame packet
AUD (audio info-frame data)	To check the source audio info-frame packet

#### CEC Command

Option	Description
Stand by	
Active source	
Monitor (read)	

#### Audio Return

Option	Description
Audio Return	On/Off

#### Deep Color Set

Option	Description
8 bit	On/Off
10 bitt	On/Off
12 bit	On/Off

**Note:** The device will auto detect sink device's deep color and when any of the deep color is not supported the option in the deep color set will not be selectable.

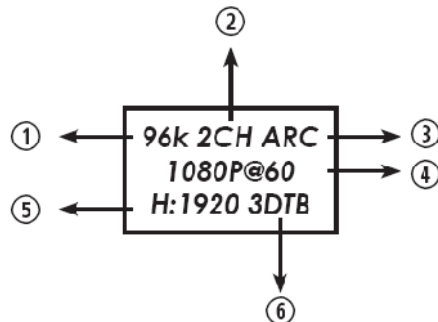

OLED

**1. Sampling Rate:** The device support audio sampling rate of 48/96/192KHz and the OLED will display it according to the selection, if external audio is selected the OLED will display bypass.

**2. Audio Channels:** The device support audio channels from LPCM 2, 5.1 and 7.1CH, if external audio is selected the OLED will display bypass.

**Note:** When the audio button is pressed constantly for 3 seconds, both 1 & 2 will show AUDIO MUTE.

**3. ARC:** Audio Return Channel, when the function is selected the OLED will display ARC if not, the OLED will not illuminate ARC.

**4. Timing Frequency & V Sync :** Please referes to section 10. Timing Table for the supports timing and V sync details.

**5. H Sync:** Please referes to section 10. Timing Table for the supports H sync details.





**6. 3D PATTERN:** Only when the 3D pattern is selected, the OLED will show the pattern details.

**Note:** When in EXT Mode, the OLED will display the input H/V Sync with timing frequency and 3D pattern if any.

## Timing Table

No.	Resolution	V Hz	No.	Resolution	V Hz
T01	480p	60	T14	1024x768	60
T02	480i	60	T15	1280x1024	60
T03	720p	60	T16	1920x1200	60
T04	1080i	60	T17	720p(3D Frame Packing)	60
T05	1080p	60	T18	720p(3D Side by side)	60
T06	576i	50	T19	720p(3D Top to Bottom)	60
T07	576p	50	T20	720p(3D Frame Packing)	50
T08	720p	50	T21	720p(3D Side by side)	50
T09	1080i	50	T22	720p(3D Top to Bottom)	50
T10	1080p	50	T23	1080p(3D Frame Packing)	24
T11	1080p	24	T24	1080p(3D Side by side)	24
T12	640x480	60	T25	1080p(3D Top to Bottom)	24
T13	800x600	60			

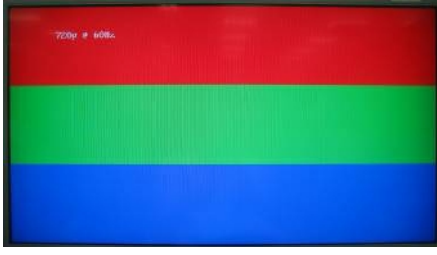
**Support Pattern Table**

Group	No.	Pattern	Description
Standard Type	1		Primary colors: Red, Green, Blue  P1: Red P2: Green P3: Blue
	2		
	3		
	4		P4: Horizontal RGB Bar
	5		P5: H Grey Scale

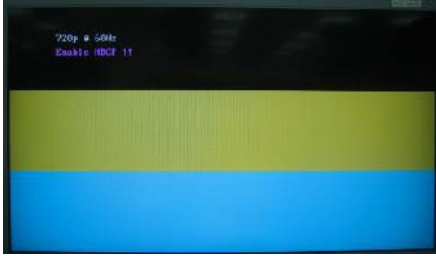
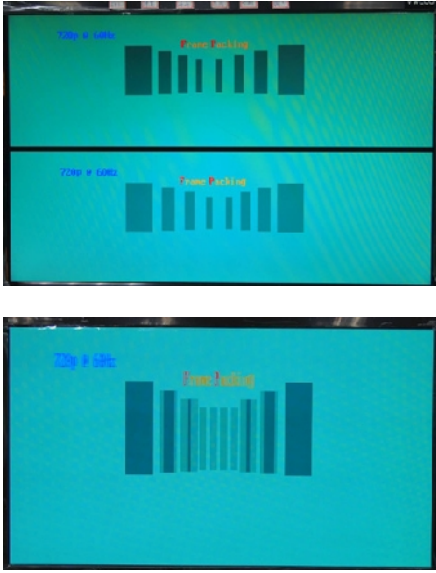
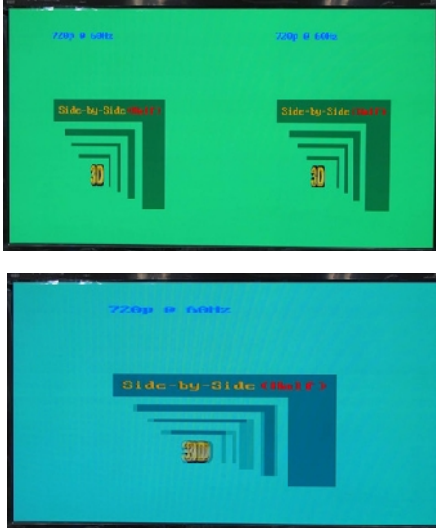

Standard Type (cont)	6		P6: HDCP handshaking and link-integrity test
3d Type	*7 (FP)		P*7(FP): Frame Packing
	*7 (SH)		P*7(SH): Side-by-Side (Half)

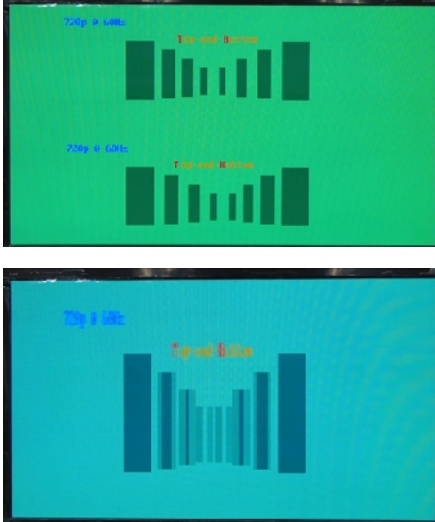
3D Type (cont)	*7 (TB)		P*7 (TB): Top-and-Bottom
-------------------	------------	--	--------------------------

**Note:** \*7 means Left hand side will present on 2D display, right hand side will present on 3D display.  
 3D FP means 3D Frame Packing  
 3D SH means 3D Side-by-Side (Half)  
 3D TB means 3D Top-and-Bottom

## Connection

For checking both source and display's information, press M/↵ to display System Information.

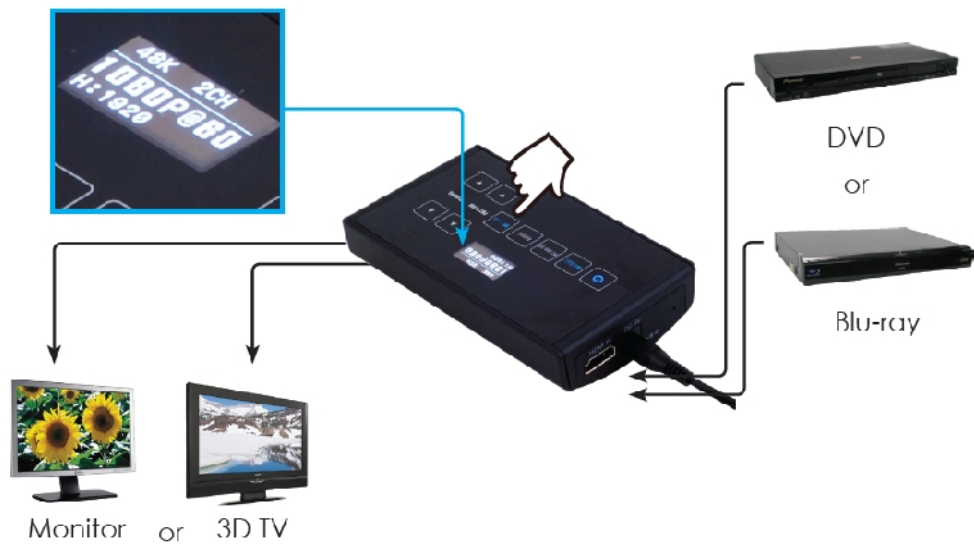

For checking display's support timing, connect HDMI output only to the display and press the PATTERN and TIMING button.

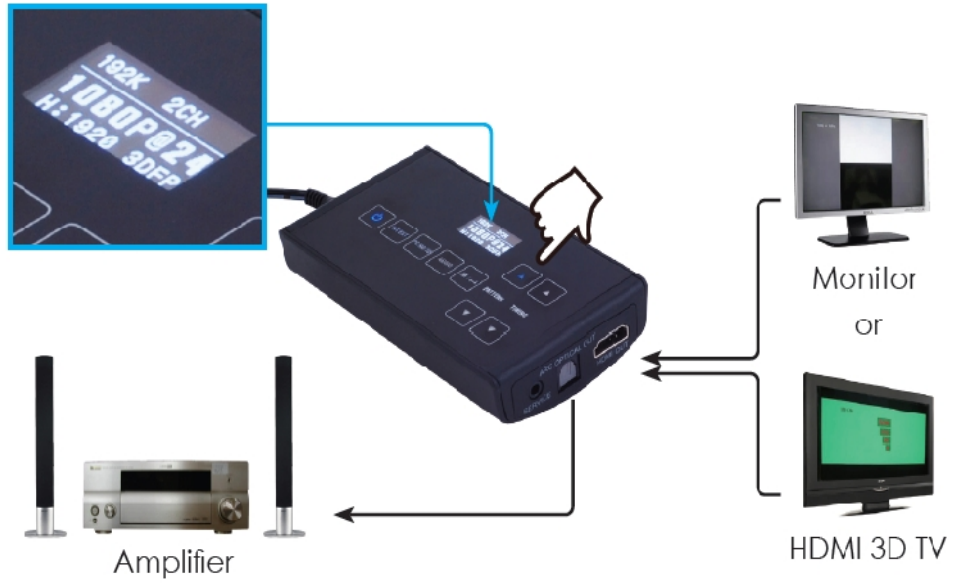

## Specifications

<b>TMDS Clock Frequency</b>	225MHz
<b>Input Port</b>	1 x HDMI (Female type)
<b>Output port</b>	1 x HDMI (Female type)
<b>EXT Mode (HDMI input)</b>	
<b>HDMI Resolution</b>	480i/p, 576i/p, 720p~1080p
<b>PC Resolution</b>	VGA~WUXGA
<b>3D Resolution</b>	Support all 3D timing
<b>INT Mode (internal pattern)</b>	
<b>HDMI Resolution</b>	480i/p, 576i/p, 720p~1080p
<b>PC Resolution</b>	VGA~SXGA, WUXGA
<b>3D Resolution</b>	Frame Packing (1080p@24,720p@50/60 ) Side-by-Side (Half) (1080p@24, 720p@50/60) Top-and-Bottom (1080p@24/ 720p@50/60)
<b>Audio Format</b>	480i/p, 576i/p or VGA~SVGA support LPCM 2CH 48/96/192kHz, LPCM 5.1CH 48kHz, LPCM 7.1CH 48kHz, 720p~1080p or XGA~WUXGA support LPCM 2CH, 48/96/192kHz, LPCM 5.1CH 48/96kHz, LPCM 7.1CH, 48/96kHz
<b>HDMI Cable In</b>	1080p/8bits 15M, 1080p/12bits 10M
<b>HDMI Cable Out</b>	1080p/8bits 15M, 1080p/12bits 10M
<b>ESD Protection</b>	Human Body model: ± 8kV (air-gap discharge) ± 4kV (contact discharge)
<b>Power Supply</b>	5V/1A DC (US/EU standards, CE/FCC/UL certified)
<b>Dimensions (mm)</b>	119.5 (W) x 70 (D) x 25 (H)
<b>Weight(g)</b>	128
<b>Chassis Material</b>	Plastic
<b>Silkscreen Color</b>	Black
<b>Operating Temperature</b>	0°C~40°C / 32°F ~ 104°F
<b>Storage temperature</b>	-20°C~60°C / -4°F ~ 140°F
<b>Relative Humidity</b>	20~90% RH (no condensation)
<b>Power Consumption (W)</b>	4W (Max)

### Note:

**A.** This system was tested with 24AWG cables if using cables of another type, the performance of this system may be different.

**B.** Cable distance tested with a PS3 & 40" Samsung UA40B700 12-bits LED TV.

**C.** Figures provided in this manual are for reference only, actual figures may depend on the source and display used along with the cables specifications.