

**17 Inch Desk Mount Multi-Frequency  
CGA/EGA/VGA LCD Panel ID#971**



**Operation Manual**

## Introduction

This monitor is a Desk Mount Multi Frequency LCD Panel monitor. It features the VESA plug & play system which allows the monitor to automatically adjust itself to match the frequency of the user's device.

## Features

- High brightness.
- Fast response time.
- Power saver.
- Low electromagnetic wave and power saver.
- Safety certifications.
- CGA, EGA and VGA multi-system

## Power Saver

- The power control system is installed inside the LCD monitor.
- If the monitor has not been used for a certain period of time, the system will turn the monitor to low voltage mode to save power. Any button press will return the monitor to original state.
- Your input device e.g. your computer controls the power saver mode. You can adjust these settings via your computer
- The LCD monitor is compatible with EPA Energy Star and N Tek if used with a VESA DPMS computer.
- To save power, turn off the power of the LCD monitor when it is not in use.

## Plug and Play

- The VESA plug and play function eliminates the complicated and time-consuming installation process.
- As this is a plug and play monitor. Your computer system can easily identify and automatically adjust the monitor.
- The LCD monitor uses Display Data Channel (DDC) to send Extended Display Identification Data (EDID) to the computer system, so the computer system can be set to monitor auto adjust.

## Setting up your LCD monitor

### Screen Adjustment

To enter adjust mode, please refer to the OSD control.

- Turn the computer and LCD monitor on.
- Press “Auto” button to start auto adjust.
- This will start the auto adjust process. This will take approximately 10 seconds. You may notice the image changing and occasionally flashing (this is normal).
- Your LCD monitor provides a self testing function, through which you can check whether the LCD monitor functions are working properly.
- If your LCD monitor is properly connected, but there is no image showing and the indicator lights up in orange, please follow the below steps:
  - Shutdown the computer and the LCD monitor.
  - Unplug the signal connector from the back of the computer.
  - Turn the LCD monitor on.
  - If the image connector is disconnected or damaged, a “No signal input” sign will pop up on the monitor.



**NO SIGNAL INPUT**

- Turn off the LCD monitor and reconnect the signal cable, and then turn the computer and LCD monitor on.
- If the LED of the LCD monitor is an orange colour after completing the steps above, please check your VGA card and computer system. Your monitor should be operating properly.



**OUT OF RANGE**

- If the “out of range” error pops up on the monitor, the input frequency is outside of the specified range and will not display an image. The correct frequency will need to be entered and then restart the monitor.

## Panel Controls

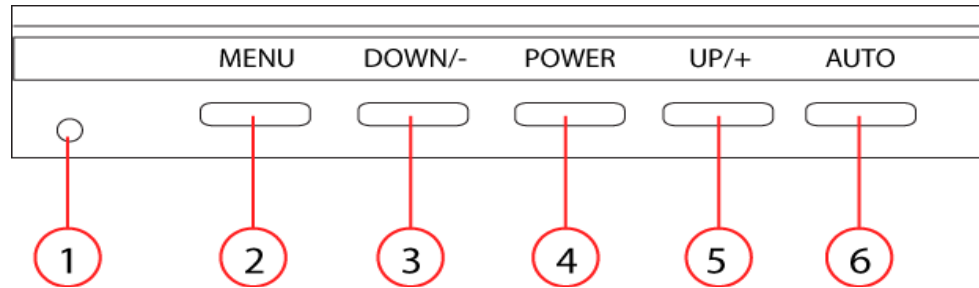

1.	<b>LED</b>	Green : Power On
		Red : Standby or not connected
		Off : Power off
2.	<b>Menu</b>	This button is used to display the ON Screen Display (OSD) menu.
3.	<b>Down/-</b>	This button is used for selection or adjustment when OSD is shown and decreasing volume..
4.	<b>Power Switch</b>	Power On/Off.
5.	<b>Up/+</b>	This button is used for adjustment when OSD is shown and increasing volume.
6.	<b>Auto</b>	Automatically optimize positions, phase and clock when OSD is not shown.

## Adjusting the Image

- Press the menu button to start the OSD feature.
- Click the “Up” or “Down” button to select the function to be adjusted.
- Click the “Menu” button to access into the function to be adjusted.
- Click the “Up” or “Down” button to change the current setting of the function selected.
- To exit the OSD menu or go back to a previous menu click the “Auto/Esc” button. Upon exiting the menu your changes will automatically saved.
- If after pressing the menu button, the OSD button will disappear, if no additional buttons are pressed for several seconds. If this occurs, any adjustments made, will still be automatically saved.
- Due to the automatic save feature, turning off the power is unwise while navigating the menu.

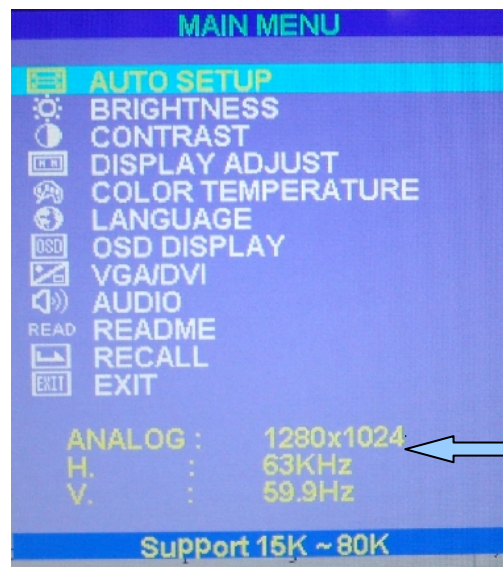

Detects and displays current input setting

**Please Note:** Due to the advanced nature of this panel. Adjustments to clock, phase and image positioning are saved only for the signal timing you are currently using. Meaning if your input is CGA 640 x 215 @60Hz, and you adjust the clock setting. This will only affect this timing.

So when your change input to VGA 640 x 480 @60Hz for example the clock will be at its default (or last memory saved setting). This is to allow the user to get a picture perfect for every input he requires and avoid redoing settings each time the input is changed. Except for these adjustments, clock, phase and image positioning, all other adjustments are universal for example changing the brightness setting will change the brightness setting for all inputs and timings.

To help the User remember; all settings that only affect the timing you're currently using are coloured pink and the universal settings are coloured white.

## OSD Menu Options

<b>Menu</b>		
<b>Auto Setup</b>	Automatically optimize positions, phase and clock	
<b>Brightness</b>	<b>Brightness</b>	Adjust Screen Brightness
	<b>Recall</b>	Restore to Default
	<b>Return</b>	Exit menu
<b>Contrast</b>	Adjust the Screen Contrast	
<b>Display Adjust</b>	<b>H Position</b>	Adjust the Horizontal Positioning
	<b>V Position</b>	Adjust the Vertical Positioning
	<b>V Size</b>	Adjust the Vertical Screen Size
	<b>Clock</b>	Adjusts horizontal alignment
	<b>Phase</b>	Adjusts horizontal alignment
	<b>Quality</b>	Adjusts the quality of the image
	<b>Mode Selection</b>	Default Analog VGA in
	<b>Recall</b>	Restore to Default
	<b>Return</b>	Exit menu
<b>Colour Temperature</b>	<b>9300k</b>	Set up the colour temp. to be 9300 K white colour.
	<b>7500k</b>	Set up the colour temp. to be 7500 K white colour.
	<b>6500k</b>	Set up the colour temp. to be 6500 K white colour.
	<b>Auto Gain</b>	Auto Colour adjustment
	<b>Red</b>	Adjust the Red colour values
	<b>Green</b>	Adjust the Green colour values
	<b>Blue</b>	Adjust the Blue colour values
	<b>Return</b>	Exit menu
<b>Language</b>	Choose language from English, French, Italian, Chinese, Japanese	

<b>OSD Display</b>	<b>OSD H-Pos</b>	Position the OSD menu horizontally on screen
	<b>OSD V-Pos</b>	Position the OSD menu vertically on screen
	<b>OSD Timer</b>	Set the OSD menu on screen display time
	<b>OSD Transparency</b>	Set the OSD menu Transparency
	<b>OSD Direction</b>	Set the direction of the OSD menu : Normal, Mirror, Left, Right, Up or Down
	<b>Display Logo</b>	Display Logo
	<b>Recall</b>	Restore to Default
	<b>Return</b>	Exit Menu
<b>VGA/DVI</b>	<b>Analog Input</b>	Selects VGA input
	<b>Digital Input</b>	Unavailable
	<b>Return</b>	Exit Menu
<b>Audio</b>	<b>Audio</b>	Mute Audio
	<b>Volume</b>	Adjust the volume
	<b>Recall</b>	Restore to default
	<b>Return</b>	Exit menu
<b>Read me</b>	Quick start Guide	
<b>Recall</b>	Restore to default	
<b>Exit</b>	Restore to default	

*Warning: Phase and Clock Settings shouldn't be touched unless you know what you're doing. Altering these values can make the image unwatchable on the screen*

**Support  
CGA/EGA/VGA  
Timings**

Type	H. Frequency. (kHz)	V. Frequency (Hz)	Resolution
CGA	15.4	58.8	640x198
CGA	15.1	57.6	640x215
CGA	15.7	60	640x215
CGA	16.0	61	640x215
CGA	16.3	62	640x215
CGA	16.6	63.4	640x215
CGA	16.800	64	640x215
CGA	15.6	50.3	640x265
CGA	18.4	50	640x350
VGA	31.469	70.087	640x400
VGA	31.469	59.940	640x480
VGA	35.000	66.667	640x480
VGA	37.861	72.809	640x480
VGA	37.500	75.000	640x480
SVGA	35.156	56.250	800x600
SVGA	37.879	60.317	800x600
SVGA	48.077	72.188	800x600
SVGA	46.875	75.000	800x600
XGA	48.363	60.004	1024x768
XGA	48.78	59.561	1024x768
XGA	56.476	70.069	1024x768
XGA	60.023	75.029	1024x768
SXGA	47.732	60.024	1280x768
SXGA	60.168	75.019	1280x768
SXGA	60.000	60.000	1280x960
SXGA	63.981	60.020	1280x1024
SXGA	79.976	75.025	1280x1024
<b>Additional Timings</b>			
	31.469	70.087	720x400
	49.726	74.551	832x624
	67.500	75.000	1152x864
	68.681	75.062	1152x870
	61.795	65.950	1152x900
	71.809	76.149	1150x900
	47.700	60.000	1360x768
	55.935	59.887	1440x900
	70.640	74.980	1440x900

**Above is just a guide, many other frequencies are accepted**



## Connecting into Monitor

### Option 1 - Using VGA Input

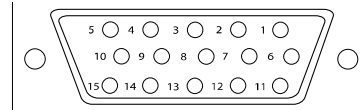

By using a standard VGA 15 pin computer cable plug and play or, alternatively you may cut the end of your cable and wire directly to the output connector of the source equipment.



<b>Pin 1</b>	Analog <b>red</b> input.
<b>Pin 2</b>	Analog <b>green</b> input.
<b>Pin 3</b>	Analog <b>blue</b> input.
<b>Pin 4</b>	Ground.
<b>Pin 5</b>	Digital ground.
<b>Pin 6</b>	Analog <b>red</b> ground.
<b>Pin 7</b>	Analog <b>green</b> ground.
<b>Pin 8</b>	Analog <b>blue</b> ground.
<b>Pin 9</b>	Ground.
<b>Pin 10</b>	Sync ground.
<b>Pin 11</b>	Ground.
<b>Pin 12</b>	SDA (DDC Data).
<b>Pin 13</b>	H. Sync or H + V Sync.
<b>Pin 14</b>	V. sync.
<b>Pin 15</b>	SCL (DDC CLK).

### Option 2 - RGB wiring via Adapter PCB

The PCB interface board is designed to facilitate connection from older style CGA/EGA/VGA source equipment. The board also allows for adjustment of incoming colour signal levels and Impedance Matching selection.

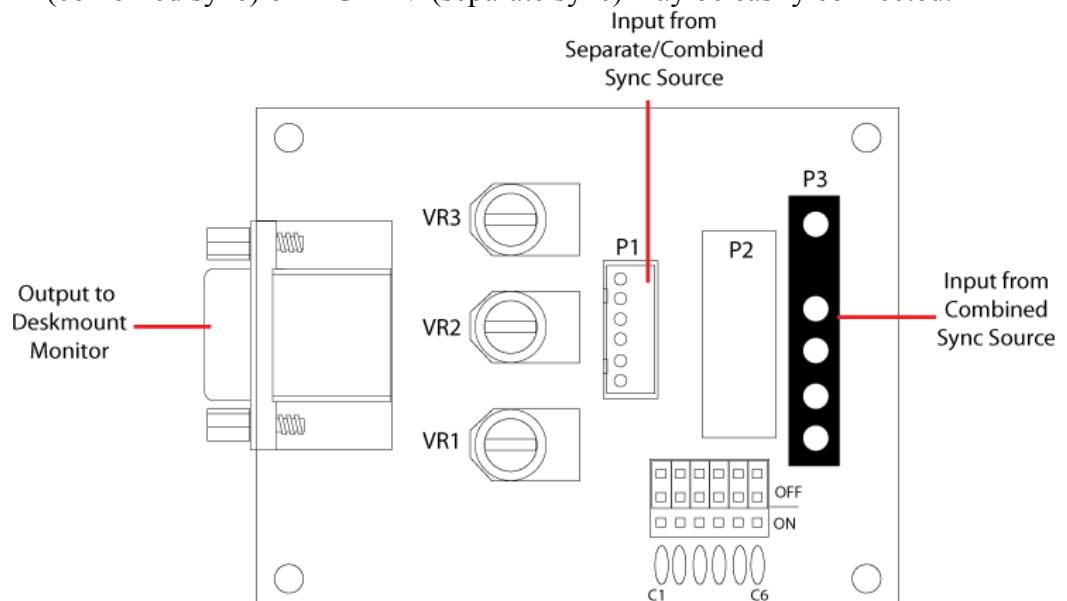
Using the supplied 5 and 6 wire open ended cables, signal formats of RGBH+V (combined sync) or RGBHV (separate sync) may be easily connected.

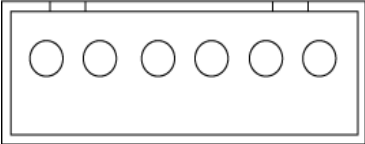

<b>P1 – RGBHV separate/combined sync</b>	<b>P3 – RGBH+V combined sync</b>
R G B E H/S V 	R G B E H/S 
Pin 1 – Red	Pin 1 – Red
Pin 2 – Green	Pin 2 – Green
Pin 3 – Blue	Pin 3 – Blue
Pin 4 – Signal Earth	Pin 4 – Signal Earth
Pin 5 – Horizontal/Combined Sync	Pin 5 – Horizontal/Combined Sync
Pin 6 – Vertical Sync	

### About Our Adapter PCB and Further Adjustments

Our adapter PCB offers a number of adjustments via the following controls

#### -VR1 to VR3

Adjust to vary the level of the individual output colour signals to compensate for over exposure/brightness of video image.

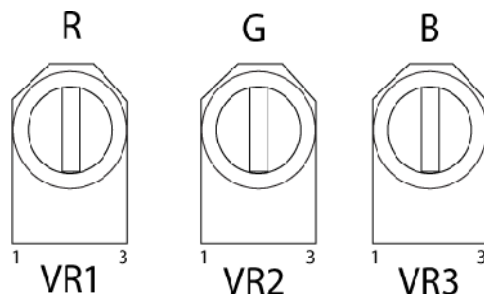

VR1 – Red  
VR2 – Green  
VR3 – Blue

| Adjusts colours to reduce the  
| signal strength if image is  
| over bright

### Filter Jumpers

Set Jumpers as required to reduce effect of black line artifacts when low resolution mismatch becomes evident on LCD screen.

By setting to "ON" position, each colour can be filtered as required.

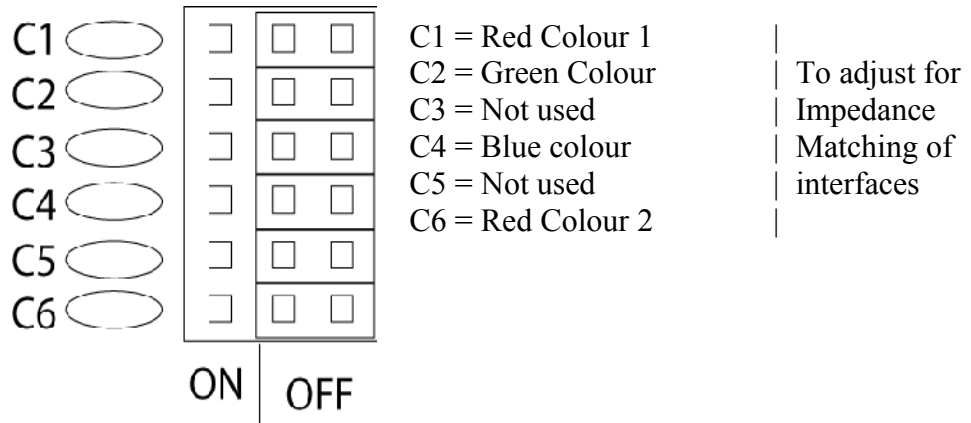

### Front/Side View

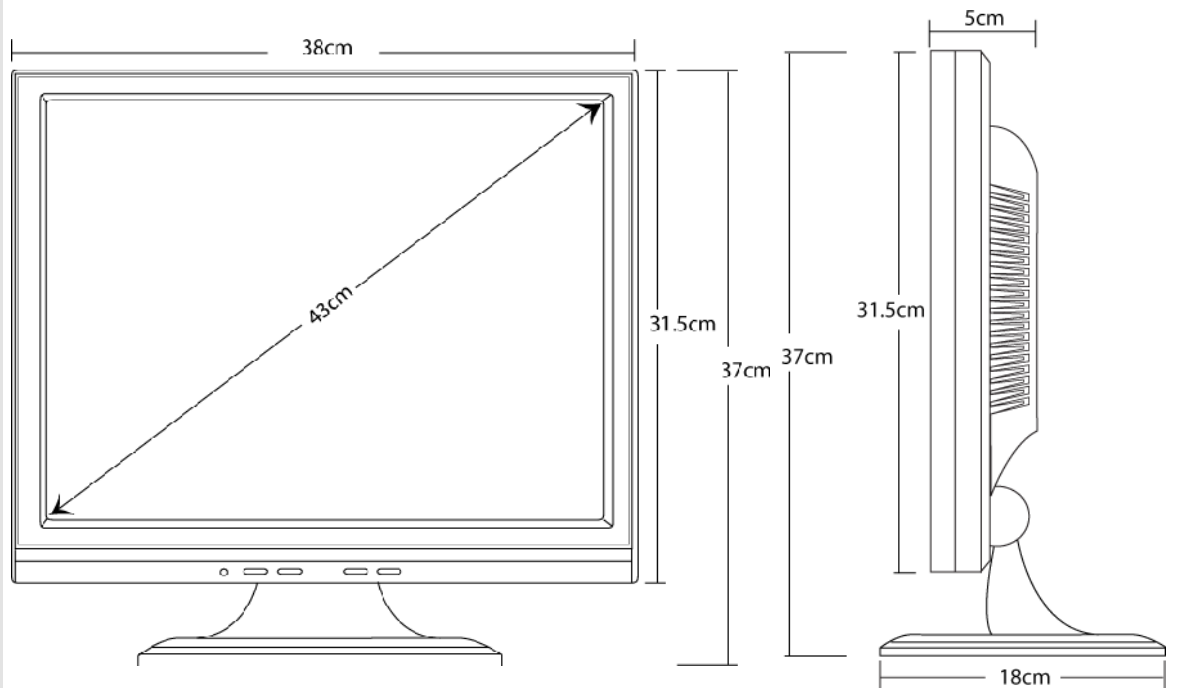

## Specifications

<b>Specifications for this Model</b>	
<b>Screen Size</b>	17" TFT
<b>Pixel Pitch(mm)</b>	0.264 x 0.264
<b>Backlight</b>	2xCCFL
<b>Cell Type</b>	TN
<b>Input Mode</b>	CGA/EGA/VGA/SXGA
<b>Scan Frequency Horizontal</b>	15 ~ 80KHZ
<b>Scan Frequency Vertical</b>	48 ~ 75Hz
<b>Colours</b>	16.2M Colors
<b>Aspect Ratio</b>	5:4
<b>Horizontal Viewing Angle</b>	Full range
<b>Max Resolution</b>	1280 x 1024
<b>Bandwidth</b>	130MHz Dot Clock
<b>Contrast Ratio</b>	500:1 Typ
<b>Brightness</b>	250cd/m2
<b>Power</b>	100~240V 47/63Hz via 12VDC 4A adapter
<b>Power Consumption</b>	13.35 Watts(Typ.)
<b>Management</b>	Vesa-Dpms 42 watts Power down mode </=3 Watts
<b>Function Keys</b>	5
<b>PC Interface</b>	Analog Interface
<b>Signal Cable</b>	Standard VGA cable w/15-pin D-sub connector. Or via VGA Inverter PCB
<b>Operating Temperature</b>	0 degrees ~ +50 Degrees
<b>Humidity</b>	10 ~ 85%

## Troubleshooting

Error	Solution
<b>No Power Led</b>	Check Mains Power supply input Voltage (100v or 240vAC) and connection
	Check 12V DC at power supply output
	Check control board for damage
<b>No image</b>	Check cables connected correctly from source and into monitor inputs
	Check correct orientation of signal wires; H-sync and V-sync
	Check for CCFL lamp operation on rear of lcd panel, visual reference only
	Check power 'on' source and monitor
<b>Image Alignment</b>	Adjust using "AUTO" button
	Fine adjust using the OSD Menu parameters accordingly for Horizontal and Vertical position/size
<b>Image Brightness/Contrast</b>	Adjust OSD Menu parameters for Brightness and Contrast
<b>Image colour</b>	Check RGB colour wires connected and active
	Adjust OSD Menu parameters for colour temperature and colour intensity
<b>Intermittent Image</b>	Ensure equipment is earthed and isolated from signal earths, <i>Note:</i> Isolation (No Earth) sometimes improves image reception
	Ensure open wire cables are sheathed and earthed against EFI (Electromagnetic Field Interference)
	Check all cable pins aligned and seated correctly